

LPS[®] System

LOW PROFILE STEP NOSE AND RACEWAY COMPONENTS



APPLICATION

Designed as part of a complete solution, the LPS system is available in solid gray or black with a 1" nominal contrasting gray stripe to help delineate the edge of walkways and aisles. The LPS Raceway, a low cost solution for both carpet trim and electrical cable routing, is designed to provide a clean transition from carpeted to uncarpeted areas on flat or sloped surfaces with the added functionality of providing a code compliant, low voltage wire way.

CONSTRUCTION

- Extruded vinyl profile in solid gray or black with a contrasting gray stripe (nominal 1")
- End caps are mechanically attached to the step nose for secure installation and durability
- Transitional components include LPS Step Reducer, Carpet Flap Extension and Carpet Edge
- Two distinct low-profile junction box designs
- Junction Boxes constructed of durable die-cast zinc
- Raceway for use with Class 2 power systems only

PERFORMANCE

- Solid gray or black with a contrasting gray stripe help visually identify the edge of steps
- Low profile design engineered to work with most popular low pile carpets
- Designed to handle step angles from 75° to 90°
- Durable, flexible vinyl extrusion conforms to uneven surfaces
- Eliminates potential hazards associated with hard PVC or aluminum extrusions
- Junction boxes designed to integrate seamlessly into a complete step and aisle lighting solution with other Tempo products

SUGGESTED COMPANION PRODUCTS

- SW3[®] Aisle, Step and Pathway Lighting
- Vanguard Illuminated Displays

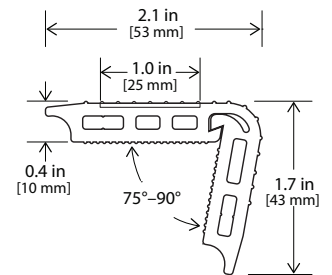

WARRANTY

Minimum 2 year limited warranty. Contact customer service for more details on warranty options.



LPS[®] System

LOW PROFILE STEP NOSE AND RACEWAY COMPONENTS

ORDERING INFORMATION

Example: LPS-GS-48

LPS Step Nose, Gray Stripe, 48" Length

LPS		
PLATFORM		
Series	Extrusion Color	Length
LPS LPS Step Nose	GY Gray	24 24"
	GS Gray Stripe	36 36"
	SPL Custom colors special order (5000ft minimum)	42 42"
		48 48"
		54 54"
		60 60"
		66 66"
		72 72"
		78 78"
		84 84"
90 90"		
96 96"		

NOTES:

Required adhesive ordered separately.

Uncut roll stock and forming machine are available for shipments outside North America.

LPS[®] System

LOW PROFILE STEP NOSE AND RACEWAY COMPONENTS

SYSTEM INTEGRATION ACCESSORIES

J-BOX		
	LPS-BK-JBX	LPS Junction Box, Black
	LPS-BK-RW-JBX	LPS Inline Raceway J-Box, Black
MISC		
	LPS-BK-CE	LPS Carpet Edge, Black, 120ft roll
	LPS-BK-SR	LPS Step Reducer, Black, 120ft roll
	LPS-BK-CFE	LPS Carpet Flap Extension, Black, 120ft roll
	LPS-BK-CFE-CUT	LPS Carpet Flap Extension, Black, Custom Cut Length, minimum 30ft roll - Consult factory for details
RACEWAY		
	LPS-BK-RW-CF-B	LPS Raceway, Black, Carpet to Floor, Base, 8ft
	LPS-BK-RW-CC-B	LPS Raceway, Black, Carpet to Carpet, Base, 8ft
	LPS-BK-RW-CV-B	LPS Raceway, Black, Carpet to VCT/LVT, Base, 8ft
	LPS-GY-RW-C	LPS Raceway, Gray, Cover, 8ft
	LPS-BK-RW-C	LPS Raceway, Black, Cover, 8ft
	LPS-BK-RW-RSR	LPS Raceway, Black, Riser, 8in, square cut in field for left or right
ROW MARKERS		
	LPS-BK-RM-2	LPS Raceway Row Marker, Black with white lettering, 2in, laser etched
	LPS-BK-RM-4	LPS Raceway Row Marker, Black with white lettering, 4in, laser etched
	LPS-RD-RM-2	LPS Raceway Row Marker, Red with white lettering, 2in, laser etched
	LPS-RD-RM-4	LPS Raceway Row Marker, Red with white lettering, 4in, laser etched
END CAPS		
	LPS-BK-EC2-L	LPS Endcap for Carpet Edge, Black, Left
	LPS-BK-EC2-R	LPS Endcap for Carpet Edge, Black, Right
	LPS-BK-EC-L	LPS Endcap for Raceway, Black, Left
	LPS-BK-EC-R	LPS Endcap for Raceway, Black, Right
	LPS-GY-EC-L	LPS Endcap for Raceway, Gray, Left
	LPS-GY-EC-R	LPS Endcap for Raceway, Gray, Right
ADHESIVE - Must be purchased from Tempo. Adhesive provided is a special formulation designed and tested to ensure product is secure, reducing the likelihood of trips and falls.		
	ADH-BOND-02	Tempo Set & Step Advanced Hybrid Adhesive, 1 tube required per 50ft of product
	ADH-SPREADER	Adhesive Spreader

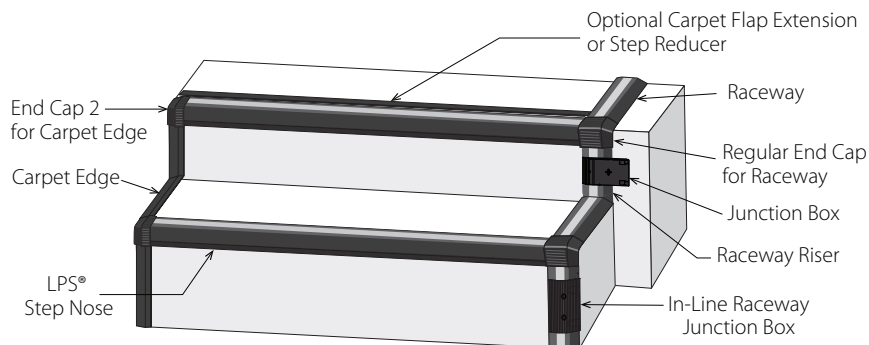

DIMENSIONAL INFORMATION

LPS Junction Box (LPS-BK-JBX)

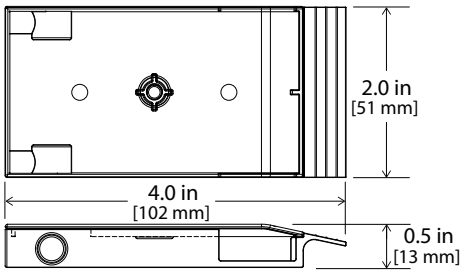

Raceway Riser (LPS-BK-RW-RSR)

Square cut one end for left or right

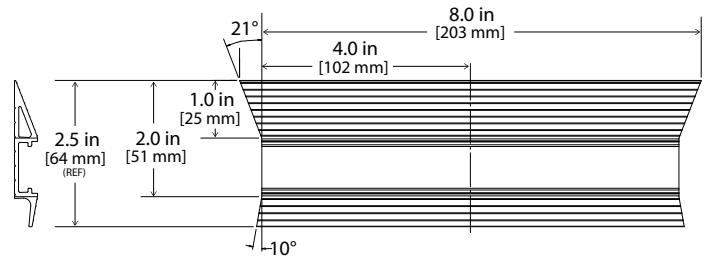

LPS Inline Raceway Junction Box (LPS-BK-RW-JBX)

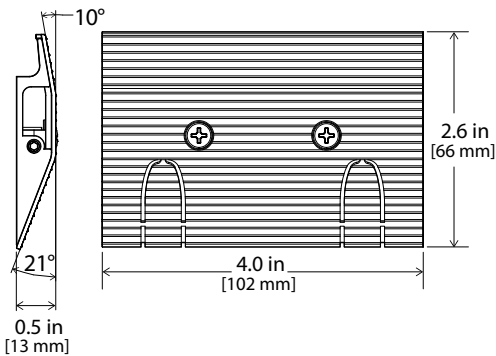

Row Marker (LPS-BK/RD-RM-2/4)

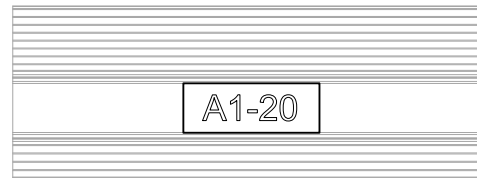

LPS Carpet Edge

(LPS-BK-CE)

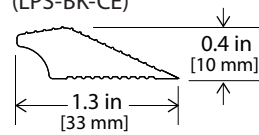

LPS Step Reducer

(LPS-BK-SR)

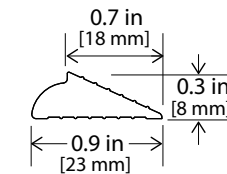

LPS Carpet Flap Extension

(LPS-BK-CFE)

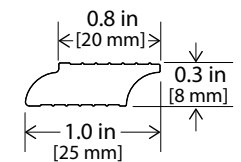

LPS Raceway Carpet to Floor

(LPS-BK-RW-CF-B)

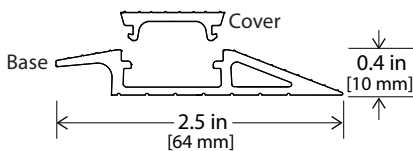

LPS Raceway Carpet to Carpet

(LPS-BK-RW-CC-B)

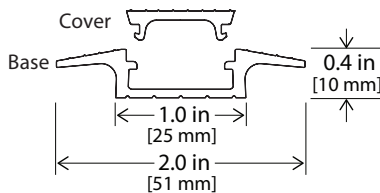

LPS Raceway Carpet to VCT/LVT

(LPS-BK-RW-CV-B)

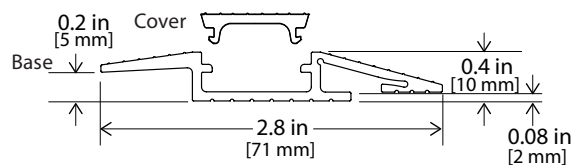

LPS Step Nose End Cap for use with Carpet Edge

(LPS-BK-EC2-L/R)

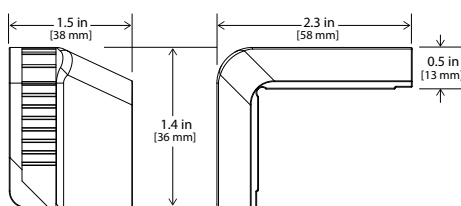

LPS Step Nose End Cap for use with Raceway

(LPS-BK-EC-L/R or LPS-GY-EC-L/R)

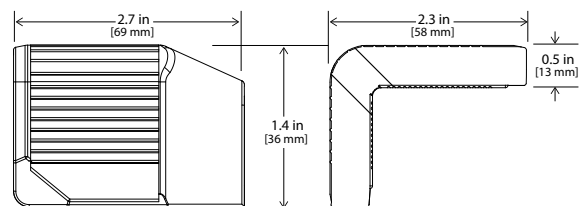

Tempo products and technologies are protected under one or more US and International patents.

Tempo reserves the right to change materials or modify the design of its product without notification as part of the company's continuing product improvement program.

Please consult www.tempollc.com for the most up-to-date specifications and technical data.