

Sentinel™ Seat Light II



APPLICATION

Tempo's Sentinel™ Seat Light II is a low voltage, class 2, LED based stairway and aisle lighting luminaire that incorporates a back-lit informational panel. The compact design of the Seat Light II is perfect for live performance auditoriums, cinemas and a wide variety of commercial and institutional applications. Designed to provide a wide and uniform distribution of light over a path of egress from a low mounting height, the Seat Light II can also direct patrons and staff via a customizable graphics panel.

The Seat Light II is extremely durable. Constructed of a two piece die cast aluminum housing with a black anodized finishing treatment along with an impact resistant acrylic lens, the Seat Light II can withstand the harshest interior environments. Utilizing high output, low energy consuming, lighting class LED's, Seat Light II offers years of maintenance free service.

CONSTRUCTION

- Rugged die Cast Aluminum Housing
- Optional illuminated row marker/graphics panel
- Impact and vandal Resistant
- Easily replaceable LED modules
- Low Voltage – Class 2 wiring
- 18 AWG wire leads (6ft) jacketed with 3/16" flex metal conduit (5ft)

POWER SYSTEM

- Remote, Class II magnetic transformer, 120V AC input, 12V AC output.
- 29VDC option available - transformer supplied by others.

SUGGESTED COMPANION PRODUCTS

- LPS® and Guardian – Gray Stripe Step Nose extrusion
- LPS® – Raceway
- 12VAC Low Voltage transformers
- LPS J-Box

PERFORMANCE

- Less than 0.5 watts energy consumption
- Exceeds life safety code levels for performance environments
- Dimmable with compatible transformers
- Expected life (L85) 86,000+ hours of operation

LIGHT CHARACTERISTICS

- Available in 1600K, 2200K, 2700K, 3500K, 4000K plus Red, Green, Blue and Amber.
- 80+ Color Rendering Index (CRI)

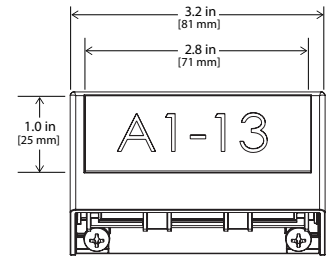

WARRANTY

Tempo provides a 2 year limited warranty. A 5 year limited warranty will apply when installed by a Tempo Certified Installer.



Sentinel™ Seat Light II

ORDERING INFORMATION

SEAT LIGHT II LED

Example: 3421 BK-27K-12-BK-10BL

3421 Series, Black Anodized, 2700K color temperature, 12V AC, Black Graphics Plate, Standard Font on Plate Graphics, Blue LED color on graphic

3421									
PLATFORM									
Series	Metal Finish	Color Temp ¹	Voltage	Graphics Plate Color	Plate Graphics (Text or Graphics)	Graphic LED Color			
3421 3421 Series	BK Black CUS Custom Consult Factory	16K 1600K 22K 2200K 27K 2700K 35K 3500K 40K 4000K RD Red GR Green BL Blue AM Amber	12 12V AC 29³ 29V DC	BK Black SPL Custom Colors on Special Order	00 No Graphic 10 Standard Font (Arial only) 20 Special Font (Text only) 40 Special Graphic ² (From Factory) 50 Custom (Customer Supplied Art)	BL Blue GR Green WH White AM Amber RD Red YL Yellow			

- (1) Consult factory for alternate color LED options.
- (2) Consult factory for specific graphics details.
- (3) 29V DC transformer by others.

SYSTEM INTEGRATION ACCESSORIES

POWER SUPPLIES		
	PWR-T010012/2	120V AC Input, 12V AC Output, 100W, 2 Circuit, Class II Magnetic Transformer, NEMA 3R Case
	PWR-T015012/2	120V AC Input, 12V AC Output, 150W, 3 Circuit, Class II Magnetic Transformer, NEMA 3R Case
	PWR-T025012/2	120V AC Input, 12V AC Output, 250W, 4 Circuit, Class II Magnetic Transformer, NEMA 3R Case
SURGE SUPPRESSION DEVICE A Tempo furnished surge suppression device must be installed on each supplying branch circuit to comply with warranty terms		
	SSD-120	120V Branch Circuit
	SSD-277	277V Branch Circuit
MOUNTING HARDWARE Required for each Seat Light II		
	3400-HARDWARE	Seat Light I & II Hardware Kit (one kit for each seat light)

Sentinel™ Seat Light II

DIMENSIONAL INFORMATION

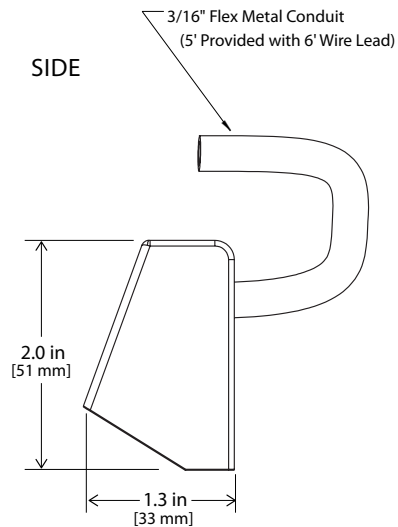
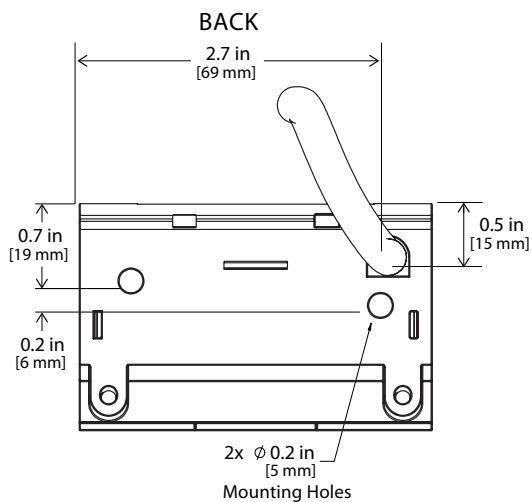
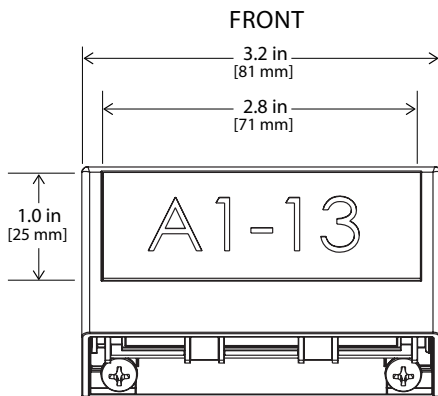

Tempo products and technologies are protected under one or more US and International patents.

Tempo reserves the right to change materials or modify the design of its product without notification as part of the company's continuing product improvement program. Please consult www.tempolc.com for the most up-to-date specifications and technical data.